







33 537 671



- 170mm projection
- fixed spout
- rectangular, air-enriched flow
- height of mixer 298 mm
- height up to aerator 230 mm
- hole diameter 35 mm
- 2x screw-in M 10 x 1 pressure hose, leak-tested
- max. flow 4.6 l/min
- lead-free
- This product can help a building meet the requirements of Green Building Rating Systems, e.g. LEED®, BREEAM®, DGNB

for use on countertop bowls

|   |                       |               |
|---|-----------------------|---------------|
|  | Chrome                | 33 537 671-00 |
|  | Brushed Platinum      | 33 537 671-06 |
|  | Dark Chrome           | 33 537 671-19 |
|  | Matte Black           | 33 537 671-33 |
|  | Brushed Chrome        | 33 537 671-93 |
|  | Brushed Dark Platinum | 33 537 671-99 |

33 537 671

mm [inches]

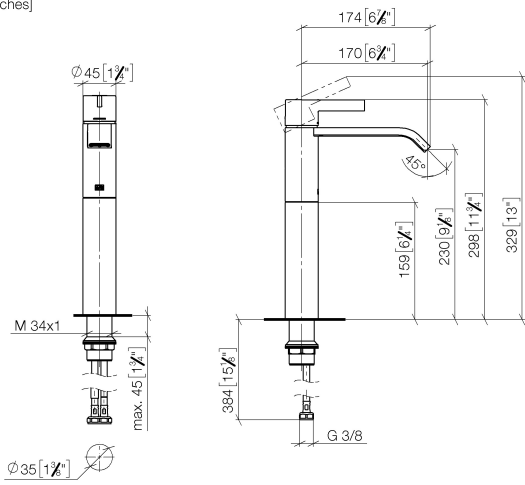

Flow rate chart

